

07 Nivelamento do Armário

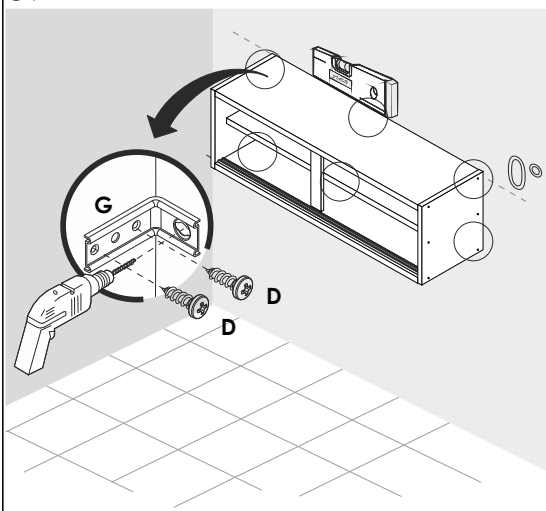

08 Furação da Parede

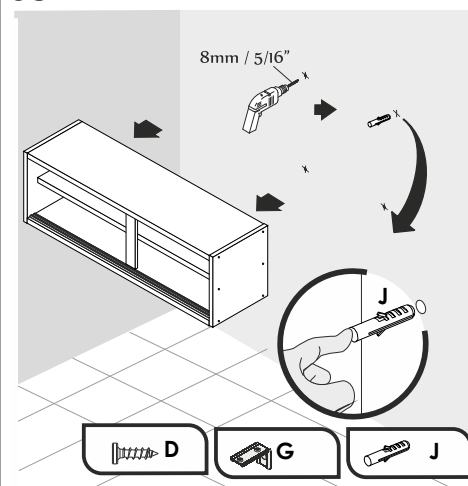

09 Montagem das Portas

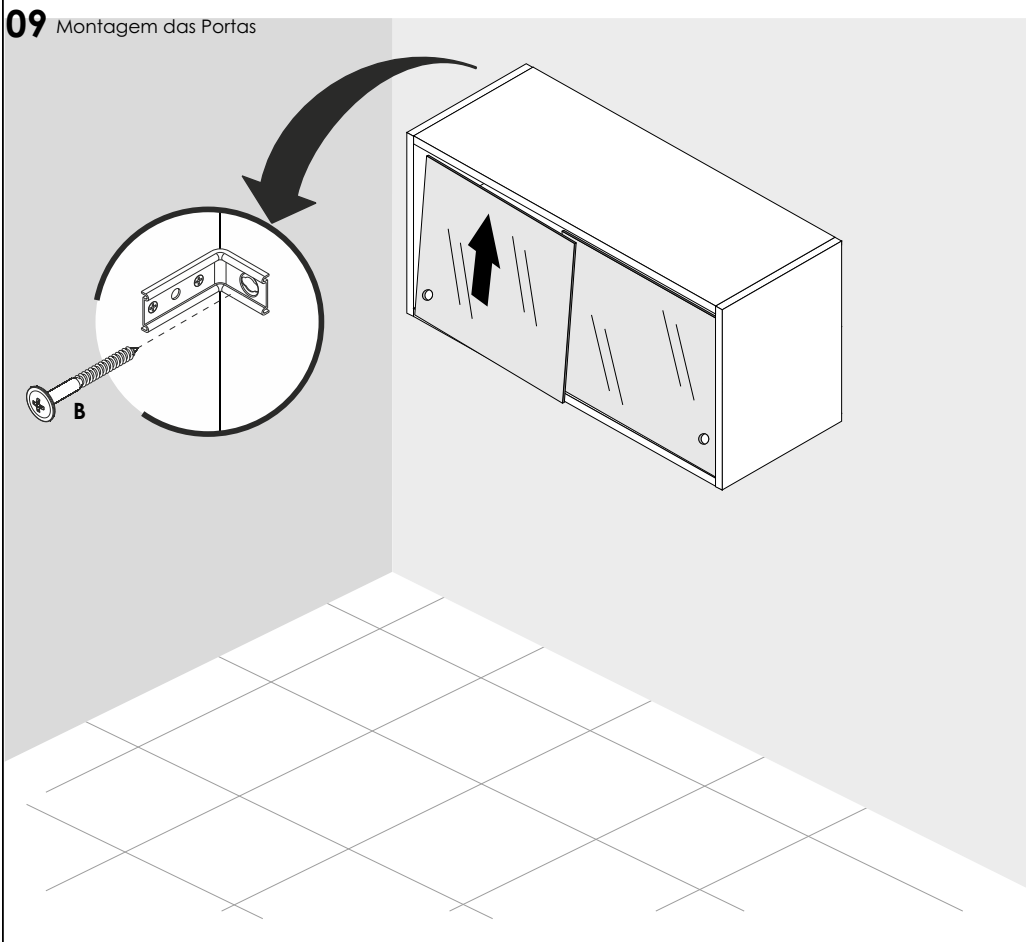



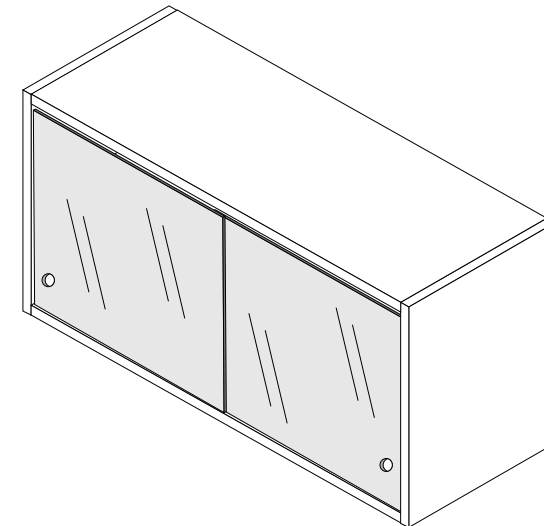



AÉREO PORTA DE CORRER REFLECTA VALENCIA 02 PORTAS

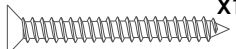
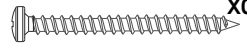

LISTA DE PEÇAS

CÓD.	Nº.	DESCRIÇÃO	COMP.	LARG.	ESP.	QT
11943	01	Tampo / Base Aéreo Porta de Correr	1175	240	12	02
11944	02	Lateral Direita / Esquerda Aéreo P. Correr	545	240	12	02
12571	03	Trava Tampo / Base Aéreo Porta Correr	520	70	12	01
11945	04	Prateleira Interna Aéreo Porta de Correr	1175	200	12	01
11947	05	Costa Horizontal Aéreo Porta de Correr	1195	269	3	02
11948	06	Porta de Vidro Aéreo Porta de Correr	600	515	3	02

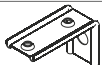
LISTA DE FERRAGENS

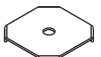
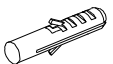
A	 X14 Parafuso 5x40 (montagem estrutura)	B	 X06 Parafuso 5X50 Flangeado	C	 X02 Cavilha 6x30
D	 X20 Parafuso 3,5x12	E	 X02 Trilho de PVC	F	 X32 Prego 8x8
G	 X06 Cantoneira de Parede	H	 X01 Conector de montagem	I	 X08 Fixador de Costas
J	 X06 Buchas de 8mm				

01 Início da Montagem

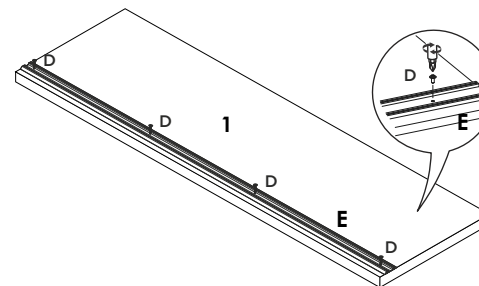

02 Montagem da Base

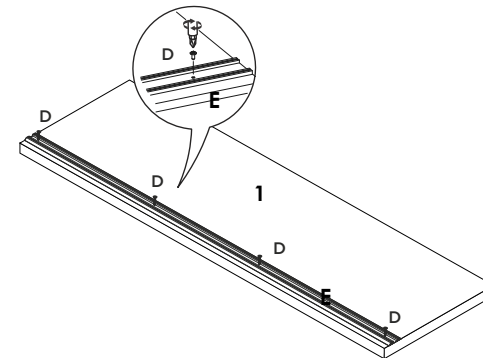

03 Montagem do Batente

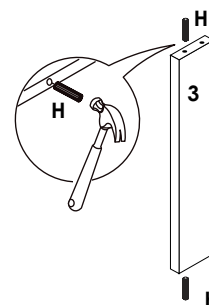

04

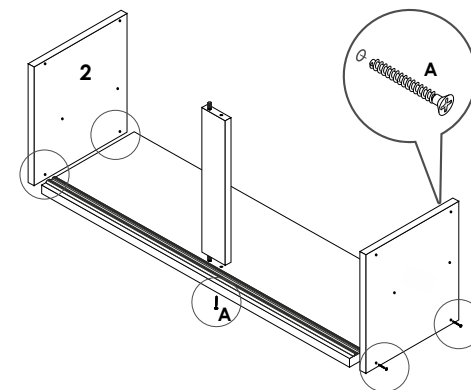

05 Montagem do Tampo e Prateleira

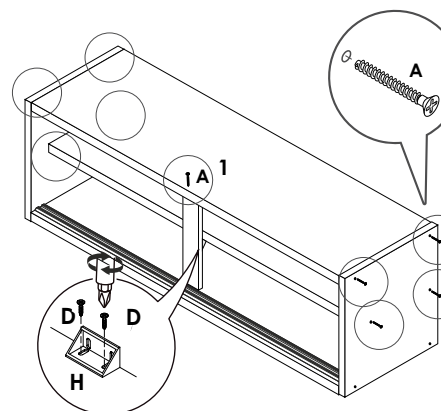

06 Montagem das Costas.

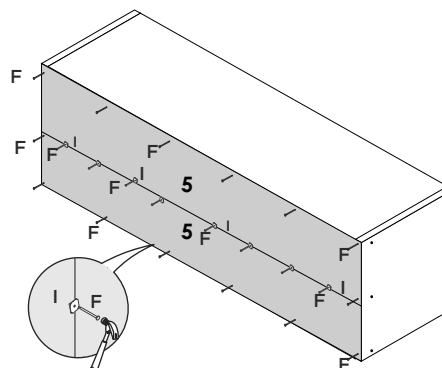

Medidas em mm

